

Data Sheet



Article number: 204050M12100A0S

Description: E+G levelling foot
GN 40-50-M12-100-A0-S

Note: S Without nut, External hexagon at the bottom

Measures

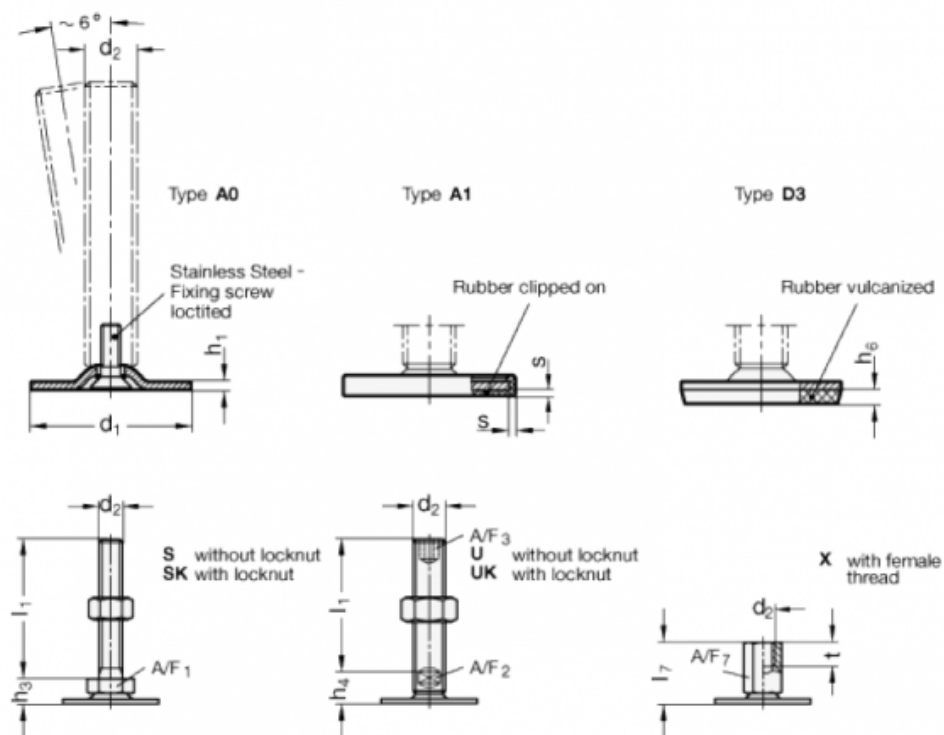

A/F1	= 17
d1	= 50
d2	= M12
h1	= 2.5
h3	= 11
h6	=
l1	= 100
s	=